



VEODAL.

SOLUTIONS PLANCHERS

DESCRIPTION



Longueur

De 0.60 m à 8.00 m
Portée entre appuis 7.90 max



Épaisseur

17.5 cm



Largeur

0.60 m



Poids

250 kg/m²

CARACTÉRISTIQUES



Coupe feu

90 minutes



Réglementation thermique

Conforme à la RT2012



Stock

15 000 m² sur parc
(au pas de 5 cm)



Réglementation Sismique

Conforme à la réglementation sismique
(zones faibles à modérées 1 à 3)
Crantage latéral



Performances acoustiques

Rw 55 à 62 db
- rapports d'essais
CSTC N° AC 6387-6389-6394



Evacuation des eaux résiduelles

Percements en usine



VEODAL.



ISOLATION

Isolation des dalles en sous face
pour les vides sanitaires (en option)



PRODUIT CERTIFIÉ
CONFORME À LA NORME NF-EN-1168



PRESENTATION

- DALLE ALVEOLEE 60 CM
- DALLE ALVEOLEE 30 CM
- POUTRELLE 12 CM
- ELEMENTS SPECIAUX
- CHEVETRE
- PHOTOS DE REALISATIONS

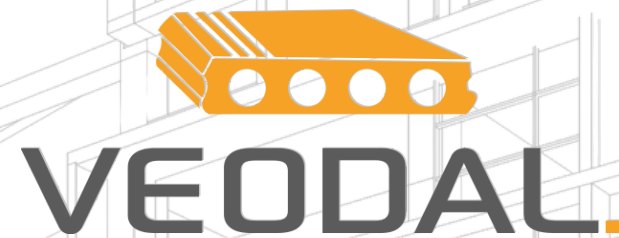

Les éléments standards du plancher VEODAL

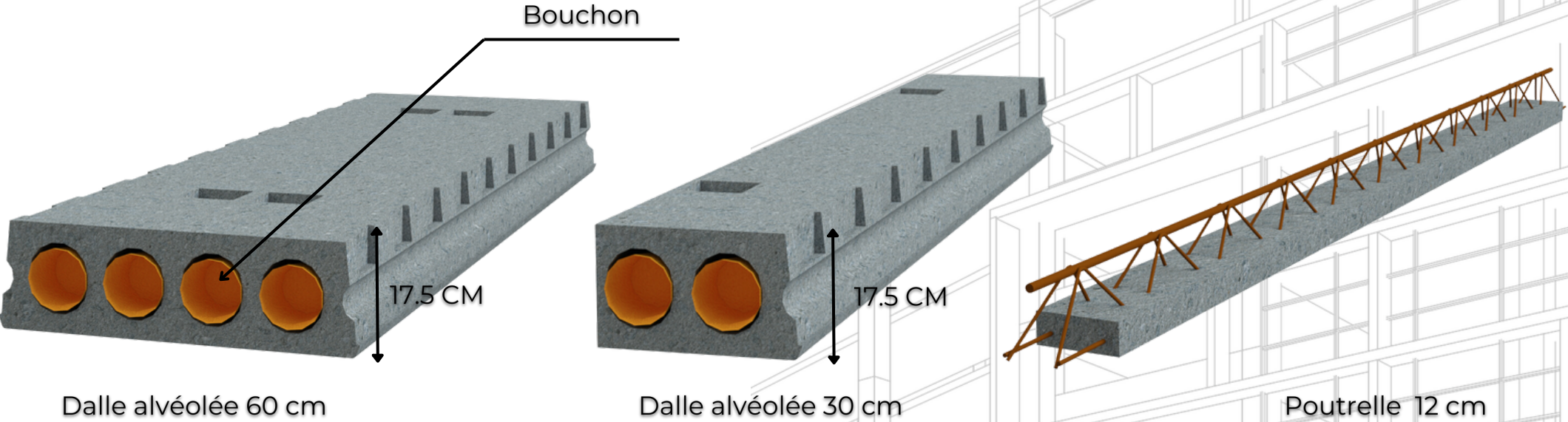



VEODAL.

LES ELEMENTS SPECIAUX



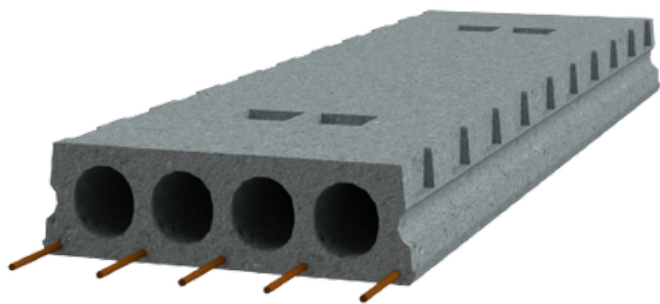

Aciers dépassants

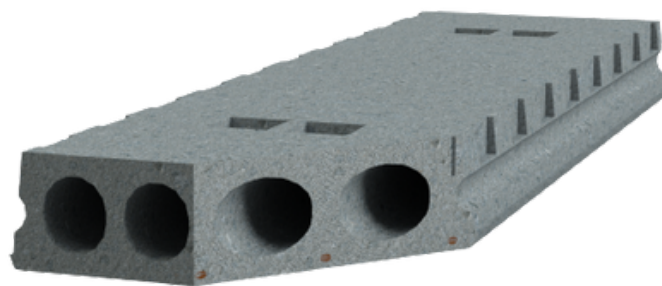

Coupe biaisée

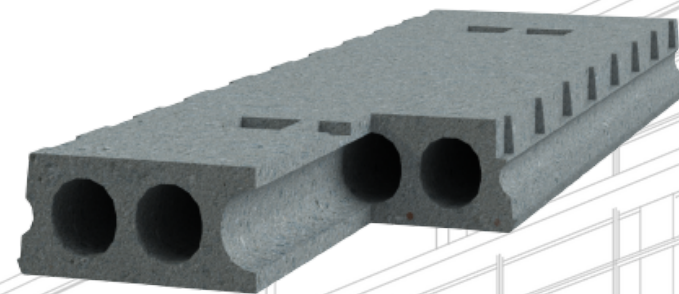

Coupe droite

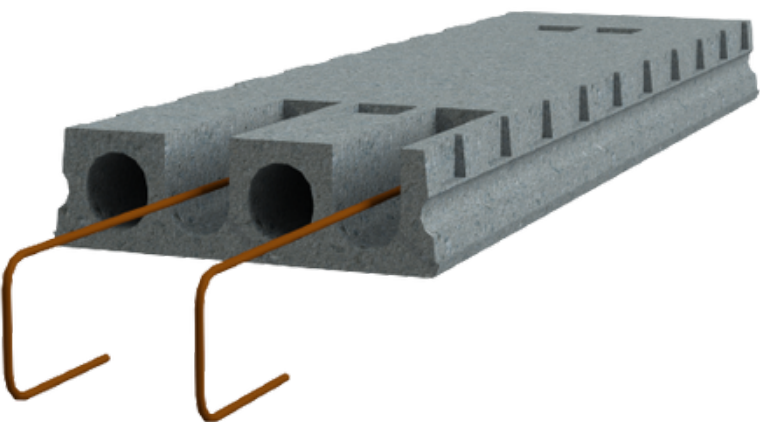

Ouvertures des alvéoles

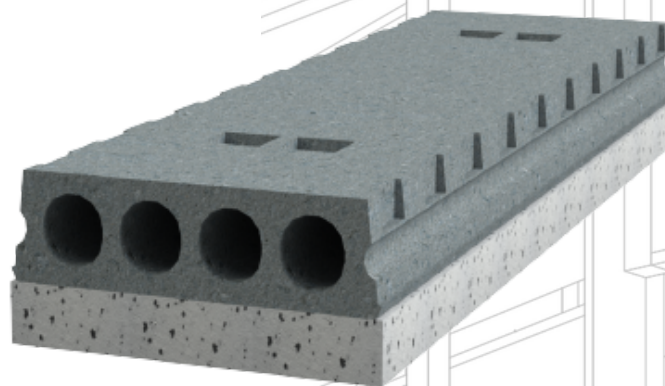

Isolation sous dalle
(uniquement en vide sanitaire)

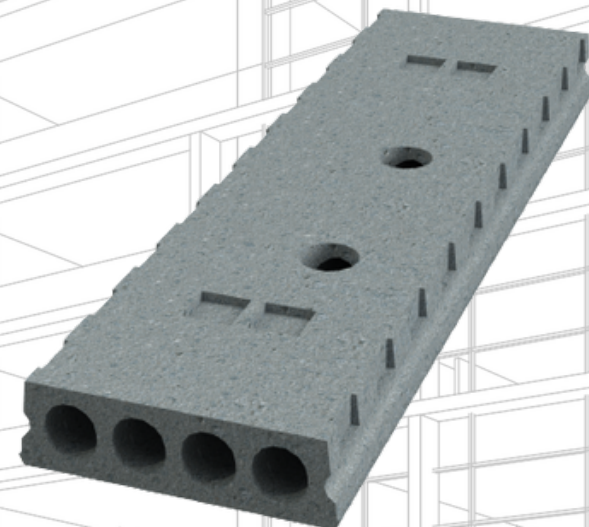

Carottages
(10 cm, 12 cm, 15 cm, 20 cm)



VEODAL.

CHEVETRE METAL



CHEVETRE METAL

Dimensions disponibles :

- 30 cm
- 42 cm
- 60 cm
- 72 cm
- 84 cm
- 90 cm
- 102 cm
- 120 cm

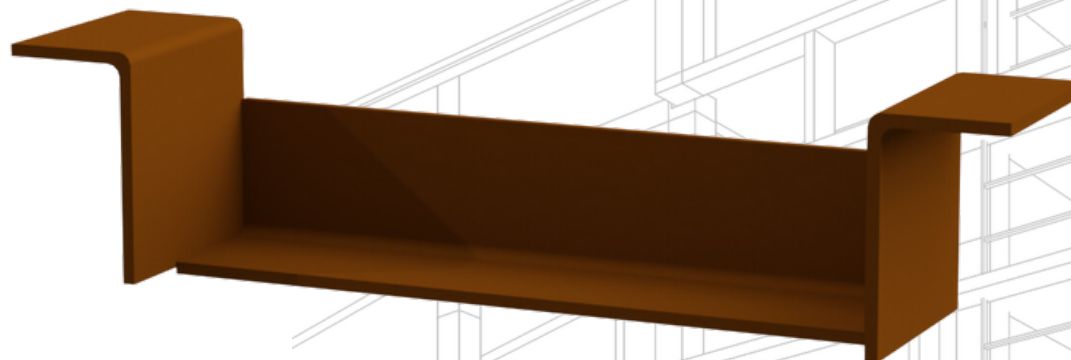

CHEVETRES EN SITUATION

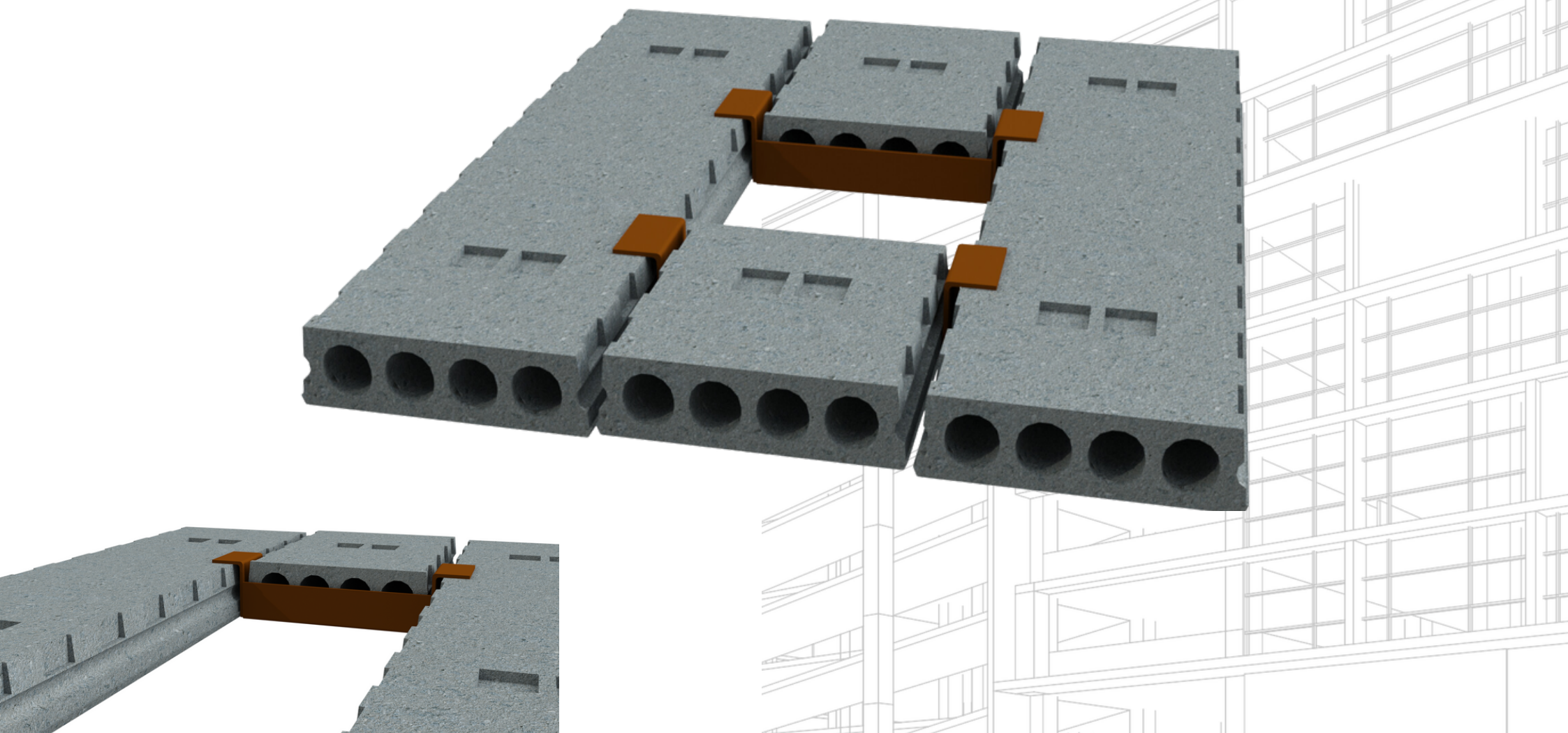

PHOTOS DE REALISATIONS





VEODAL.

NOUS CONTACTER

Mail : veodal@vermeulen.fr

ZAC du Petit Saily - 41, rue de Lille

62113 SAILLY LABOURSE

Tél : 03 21 02 29 91



Fabrication et livraison sur **toute la France**